

SZ77R5 Quick Guide 【 English 】

Front Panel



- F1. 5.25" Bay
- F2. 3.5" Bay
- F3. Eject Button
- F4. Open Door
- F5. Power Switch & Power LED
- F6. HDD LED
- F7. USB3.0 Ports
- F8. USB2.0 Port
- F9. Mic In
- F10. Headphone
- F11. USB2.0 Port & Fast Charger

Back Panel

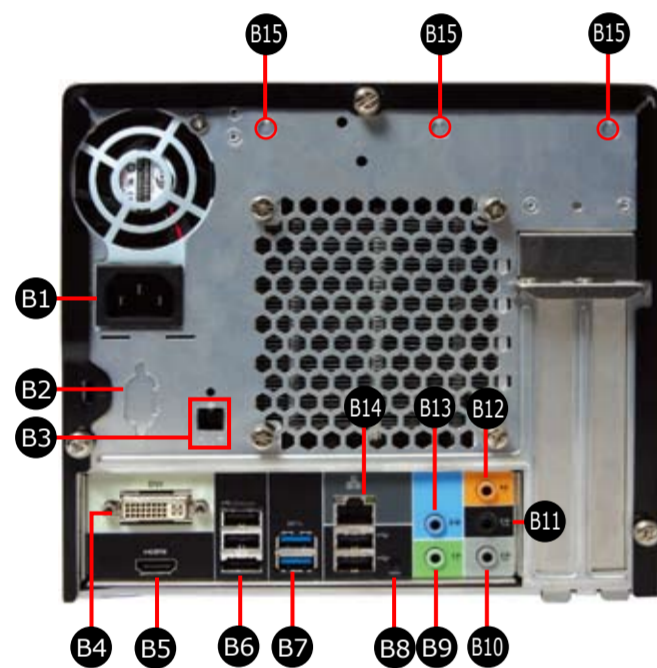

- B1. AC Power Socket
- B2. Serial Port (Optional)
- B3. S/PDIF Out Port
- B4. DVI-I Port
- B5. HDMI Port
- B6. eSATA & USB2.0 Ports
- B7. USB3.0 Ports
- B8. Clear CMOS Button
- B9. Front Speaker Out (L/R) Port
- B10. Side Speaker Out (L/R) Port
- B11. Real Speaker Out (L/R) Port
- B12. Center/Subwoofer Speaker Out Port
- B13. Line-In Port
- B14. LAN & USB2.0 Ports
- B15. Wireless LAN Perforation (Optional)

Motherboard Illustration

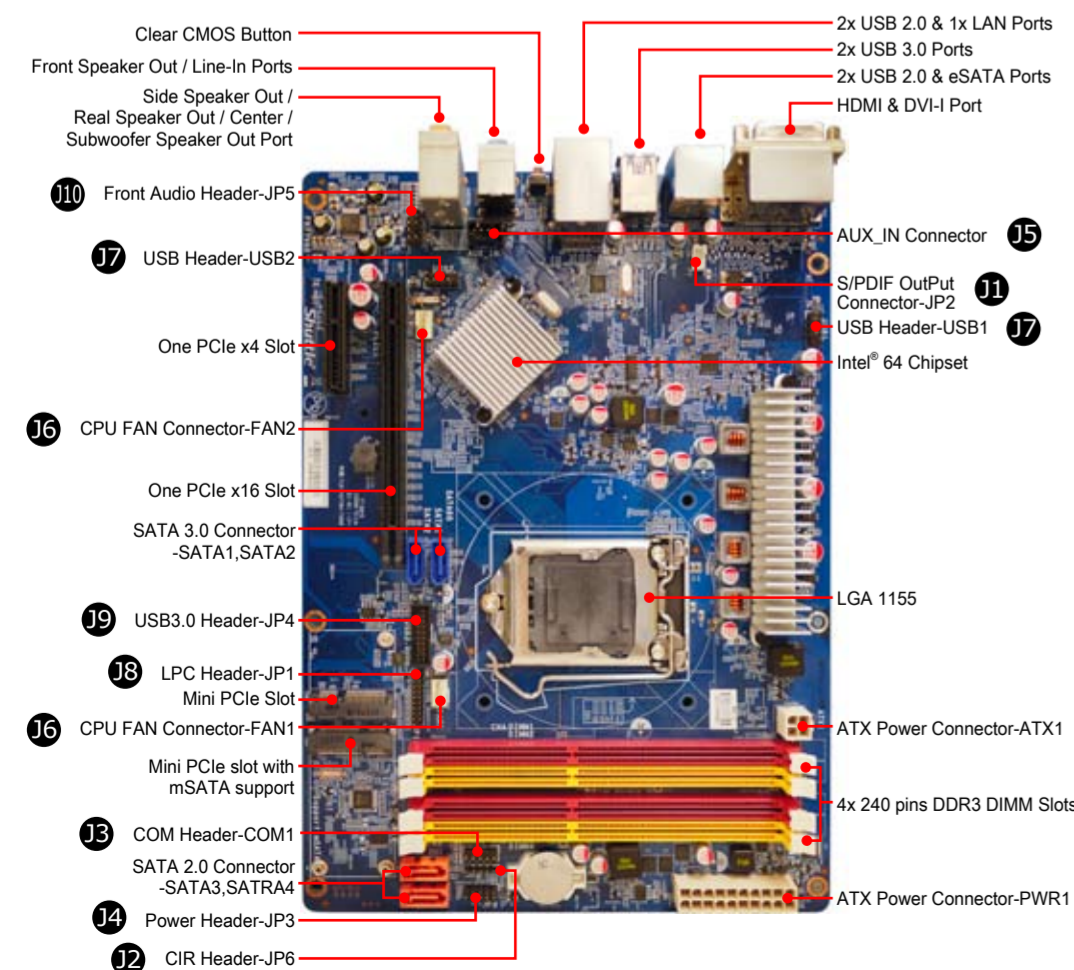

- 10. Front Audio Header-JP5
- 11. S/PDIF OutPut Connector-JP2
- 12. CIR Header-JP6
- 13. COM Header-COM1
- 14. Power Header-JP3
- 15. AUX_IN Connector
- 16. CPU FAN Connector-FAN2
- 17. USB Header-USB2
- 18. USB Header-USB1
- 19. USB3.0 Header-JP4
- 20. LPC Header-JP1
- 21. Front Speaker Out / Line-In Ports
- 22. Side Speaker Out / Real Speaker Out / Center / Subwoofer Speaker Out Port
- 23. 2x USB 2.0 & 1x LAN Ports
- 24. 2x USB 3.0 Ports
- 25. 2x USB 2.0 & eSATA Ports
- 26. HDMI & DVI-I Port
- 27. Intel® 64 Chipset
- 28. LGA 1155
- 29. ATX Power Connector-ATX1
- 30. 4x 240 pins DDR3 DIMM Slots
- 31. ATX Power Connector-PWR1



62R-SZ77R0-0601 SZ77R5
English, Spanish, Korean,
Traditional Chinese, Japanese,
French, German Quick Guide

Jumper Settings

- 11 S/PDIF OutPut Connector (JP2)**
- | | | |
|----------|-------|----------|
| 1=Ground | 2=VCC | 3=SPDIFO |
|----------|-------|----------|
- 12 CIR Header (JP6)**
- | | | | | |
|------|------|----------|---------|---------|
| 1=5V | 2=NA | 3=Ground | 4=GPIO1 | 5=GPIO2 |
|------|------|----------|---------|---------|
- 13 COM Header (COM1)**
- | | | | | | | | | | |
|-------|-------|-------|-------|----------|-------|-------|-------|--------|-------|
| 1=DCD | 2=RXD | 3=TXD | 4=DTR | 5=Ground | 6=DSR | 7=RTS | 8=CTS | 9=Ring | 10=NA |
|-------|-------|-------|-------|----------|-------|-------|-------|--------|-------|
- 14 Power Header (JP3)**
- | | | | | | | | | | |
|-----------|-----------|-----------|-------|----------|----------|-------|-------|--------|-------|
| 1=+HD_LED | 2=PWR_LED | 3=-HD_LED | 4=GND | 5=RST_SW | 6=PWR_SW | 7=GND | 8=GND | 9=NULL | 10=NA |
|-----------|-----------|-----------|-------|----------|----------|-------|-------|--------|-------|
- 15 AUX IN Connector**
- | | | | |
|-----------------|----------|----------|------------------|
| 1=AUX-IN - Left | 2=Ground | 3=Ground | 4=AUX-IN - Right |
|-----------------|----------|----------|------------------|
- 16 CPU Fan Connectors**
- | | | | |
|-------------|------|--------|----------|
| SPEED_SENSE | +12V | Ground | PWM_CTRL |
|-------------|------|--------|----------|
- 17 USB Header (USB1,USB2)**
- | | | | | | | | | | |
|----------|----------|----------|----------|----------|----------|-------|-------|------|---------|
| 1=5V_USB | 2=5V_USB | 3=USB A- | 4=USB B- | 5=USB A+ | 6=USB B+ | 7=GND | 8=GND | 9=NA | 10=NULL |
|----------|----------|----------|----------|----------|----------|-------|-------|------|---------|
- 18 LPC Header (JP1)**
- | | | | | | | | | | | | | | | | | | | | |
|--------|------|--------|----------|-----------|-----------|-----------|----------|--------|---------|---------|---------|---------|----------|------------|---------|---------|----------|--------|-------|
| 1=+12V | 2=5V | 3=5VSB | 4=SERIRQ | 5=CLK_48M | 6=CLK_33M | 7=SIO_RST | 8=LFRAME | 9=LAD3 | 10=LAD2 | 11=-12V | 12=3VSB | 13=Ring | 14=LDRQ0 | 15=SIO_PME | 16=LAD1 | 17=LAD0 | 18=+3.3V | 19=GND | 20=NA |
|--------|------|--------|----------|-----------|-----------|-----------|----------|--------|---------|---------|---------|---------|----------|------------|---------|---------|----------|--------|-------|
- 19 USB 3.0 Header (JP4)**
- | | | | | | | | | | | | | | | | | | | | |
|--------|----------|----------|----------|----------|----------|----------|------------|------------|-------|-------------|-------------|-----------|-----------|-----------|-----------|-----------|-----------|---------|-------|
| 1=5VCC | 2=A_RX_N | 3=A_RX_P | 4=Ground | 5=A_TX_N | 6=A_TX_P | 7=Ground | 8=A_Data_N | 9=A_Data_P | 10=OC | 11=B_Data_P | 12=B_Data_N | 13=Ground | 14=B_TX_P | 15=B_TX_N | 16=Ground | 17=B_RX_P | 18=B_RX_N | 19=5VCC | 20=NA |
|--------|----------|----------|----------|----------|----------|----------|------------|------------|-------|-------------|-------------|-----------|-----------|-----------|-----------|-----------|-----------|---------|-------|
- 20 Front Audio Header (JP5)**
- | | | | | | | | | | |
|---------|-------|---------|----------------|----------|--------------|---------|------|----------|----------------|
| 1=MIC_L | 2=GND | 3=MIC_R | 4=Front_Detect | 5=LINE_R | 6=Mic_detect | 7=sense | 8=NA | 9=LINE_L | 10=Line_Detect |
|---------|-------|---------|----------------|----------|--------------|---------|------|----------|----------------|

Safety Information
Read the following precautions before setting up a Shuttle XPC.

CAUTION
Incorrectly replacing the battery may damage this computer. Replace only with the same or equivalent as recommended by Shuttle. Disposal of used batteries according to the manufacturer's instructions.

Laser compliance statement
The optical disc drive in this PC is a laser product. The drive's classification label is located on the drive.

CLASS 1 LASER PRODUCT
E AUTION INVISIBLE LASER RADIATION WHEN OPEN. AVOID EXPOSURE TO BEAM.

A. Begin Installation

Warning: For safety reasons, please ensure that the power cord is disconnected before opening the case.

- Unscrew 3 thumbscrews of the chassis cover.
- Slide the cover backwards and upwards.

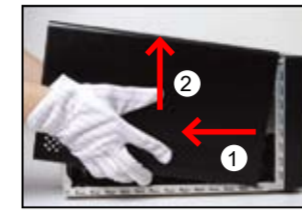

- Unfasten the rack mount screws and remove the rack.



B. CPU and ICE Installation

- Unfasten the ICE fan thumbscrews on the back of the chassis.
- Unfasten the four ICE module attachment screws and unplug the fan connector.

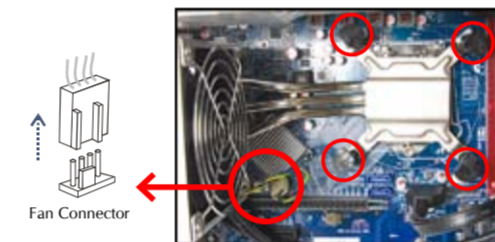

- Remove the ICE module from the chassis and put it aside.

Warning: This 1155 pin socket is fragile and easily damaged. Always use extreme care when installing a CPU and limit the number of times that you remove or change the CPU. Before installing the CPU, make sure to turn off the computer and unplug the power cord from the power outlet to prevent damage to the CPU.

Follow the steps below to correctly install the CPU into the motherboard CPU socket.

- First unlock. Press **A** with your thumb, then move it to **B** until it is released from the retention tab and raise the socket lever.

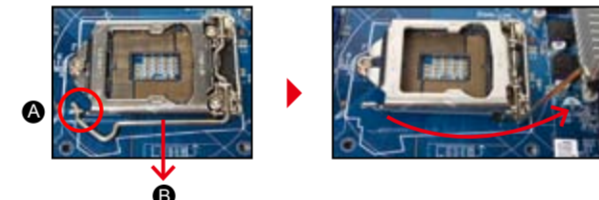

- Lift the metal load plate on the CPU socket.

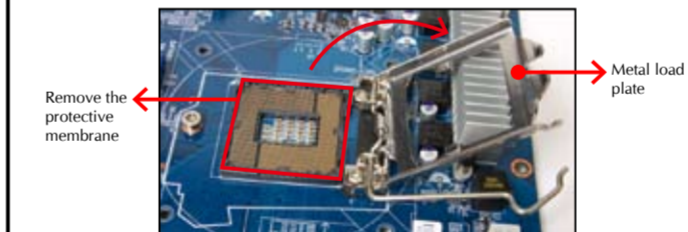

Warning: DO NOT touch socket contacts. To protect the CPU socket, always replace the protective socket cover when the CPU is not installed.

- Orientate the CPU and socket, you may align the CPU notches with the socket alignment keys. Make sure the CPU is perfectly horizontal, insert the CPU into the socket.

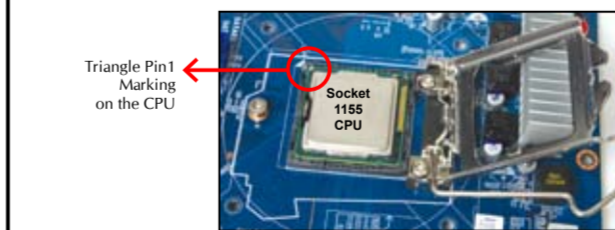

Warning: Please be aware of the CPU orientation, DO NOT force the CPU into the socket to avoid bending of pins on the socket and damage of CPU!

- Close the metal load plate, lower the CPU socket lever and lock in place.
- Spread thermal paste evenly on the CPU surface.

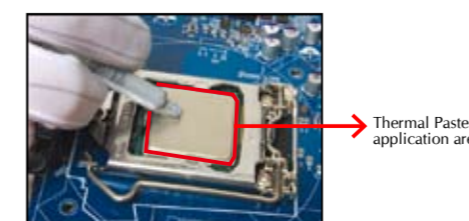

Warning: Please do not apply excess amount of thermal paste.

- Tear off the protective membrane from the bottom of ICE module. Remove the protective socket mylar from the CPU socket.

- Screw the ICE module to the mainboard. Note to press down on the opposite diagonal corner while tightening each screw.
- Connect the fan connector.

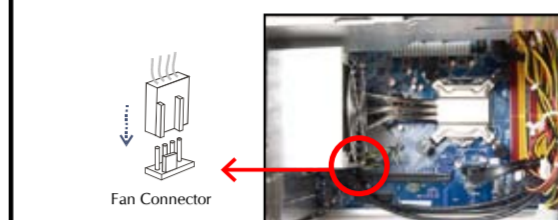

C. Memory module Installation

Guidelines for Memory Configuration
Before installing DIMMs, read and follow these guidelines for memory configuration.

Warning: Make sure that the motherboard supports the memory. It is recommended that memory of the same capacity, brand, speed, and chips are used. (Go to Shuttle's website for the latest memory support list.) Memory modules have a foolproof design. A memory module can be installed in only one direction. If you are unable to insert the memory, switch the direction.

Dual-Channel mode Population Rule

In Dual-Channel mode, the memory modules can transmit and receive data with two data bus lines simultaneously. Enabling Dual-Channel mode can enhance the system performance. The following illustrations explain the population rules for Dual-Channel mode.

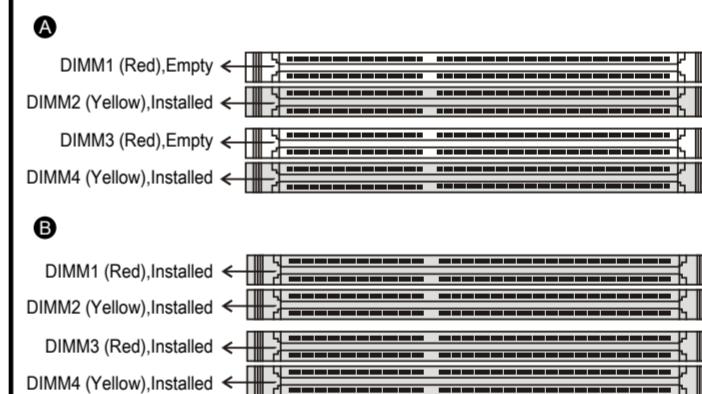

Installing a memory module

DDR3 and DDR2 DIMMs are not compatible to each other or DDR DIMMs. Be sure to install DDR3 DIMMs on this motherboard. Follow the steps below to correctly install your memory modules in the memory sockets.

- Unlock the DIMM latch.
- Align the memory module's cutout with the DIMM slot notch. Slide the memory module into the DIMM slot.

Warning: A DDR3 memory module has a cutout, so it can only fit in one direction.

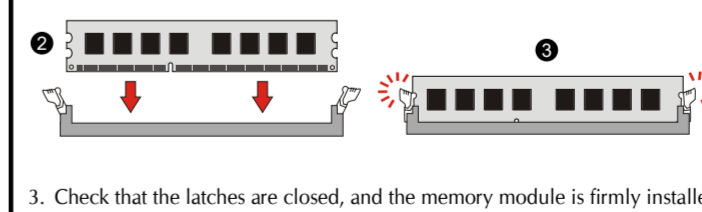
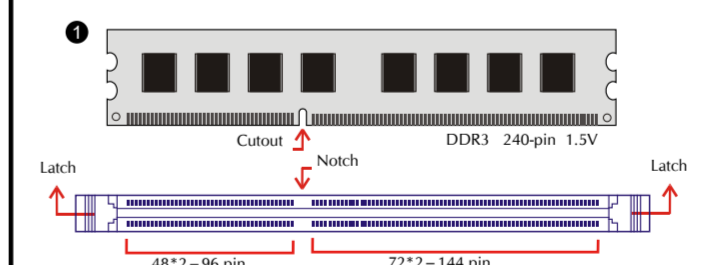

- Check that the latches are closed, and the memory module is firmly installed.



Warning: Repeat the above steps to install additional memory modules, if required.

D. Mini PCIe card Installation

- Install the Mini PCIe card into the Mini PCIe slot / mSATA Slot and affix it with screws.



E. Peripheral Installation

- Loosen the purse lock and separate the Serial ATA and power cables.
- Place the HDD and optical drive in the rack and secure with screws from the side.

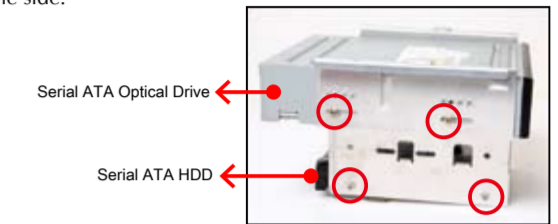

- Place the rack in the chassis and refasten the rack.

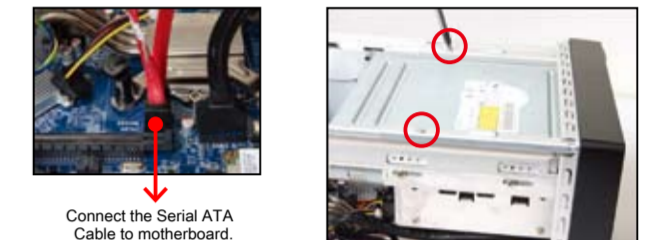

- Connect the Serial ATA and power cables to the HDD.



- Connect the Serial ATA and power cables to the optical drive.

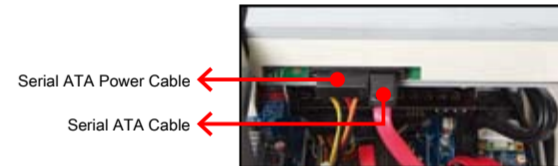

F. Accessories Installation

- Unfasten expansion slot bracket screws. Remove the back panel bracket and put the bracket aside.

Warning: The maximum size acceptable for display cards is 267mm x 98mm x 34.6mm.

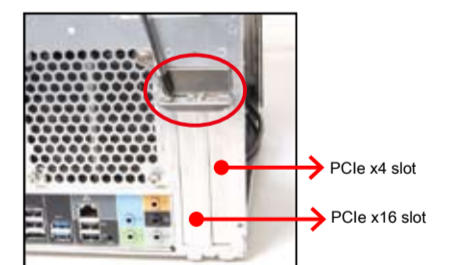

- Install the PCIe x4 / PCIe x16 card into the PCIe x4 / PCIe x16 slots.
- Secure the bracket.

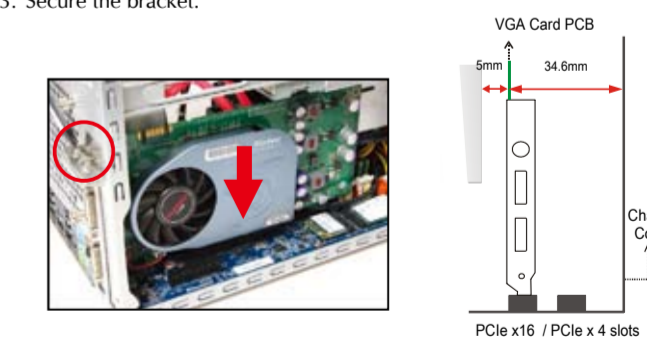

G. Complete

- Replace the cover and refasten the thumbscrews.

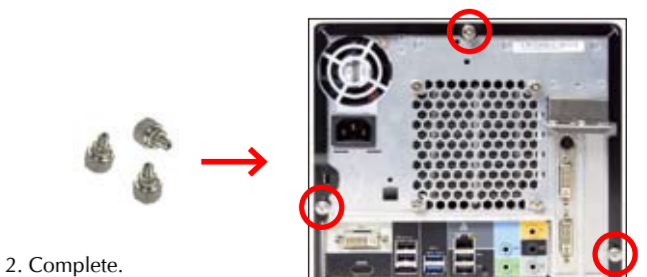

- Complete.

Warning: Please press "Del" key while booting to enter BIOS and load the optimised BIOS settings.